

Connection hoses and cables	
Water hose:	✗
Waste water hose:	✗
Electric cable:	✓

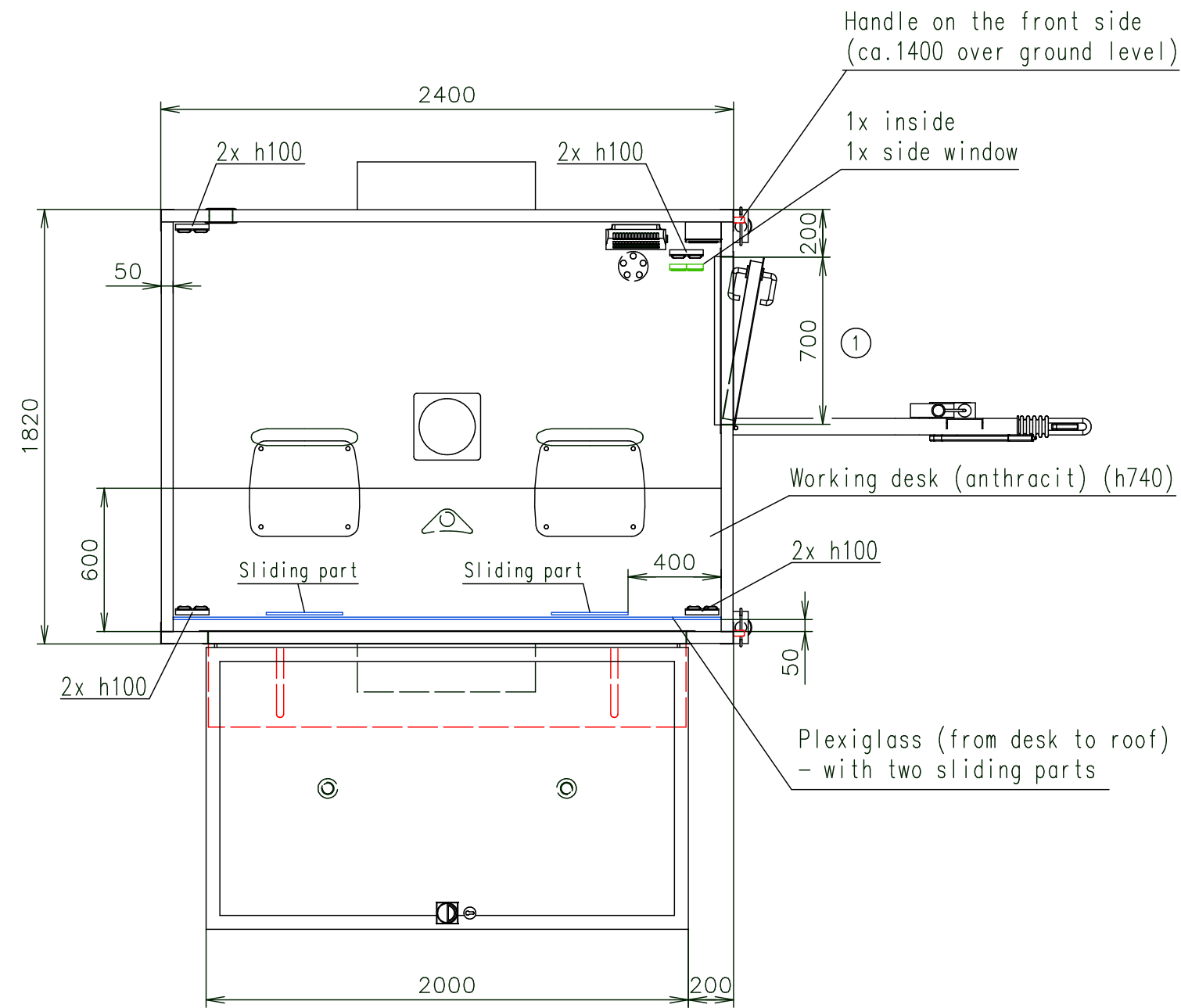

Notes:

Interior height:	2100 mm	Total weight:	750 kg
Color:	RAL 9010	Tare weight-estimate:	600 kg
Floor:	PVC gray	Centre of wheels from rear side:	1200 mm
Date:	6.9.2019	Wheels:	165/70 R13







(Cabling and piping is not shown on the 3D views and drawings)

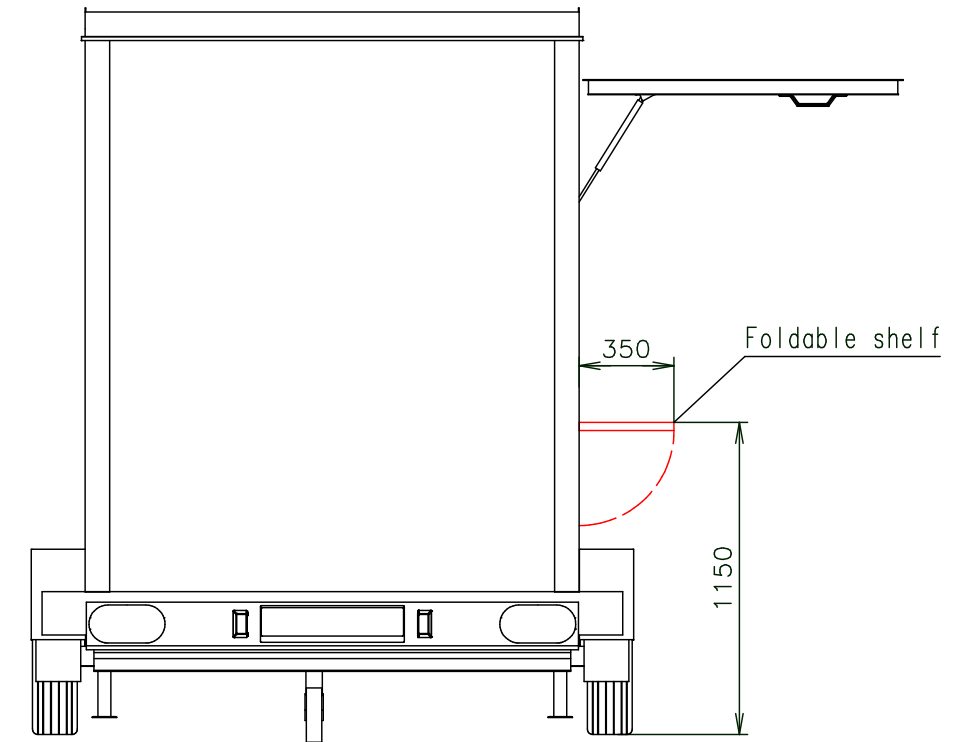
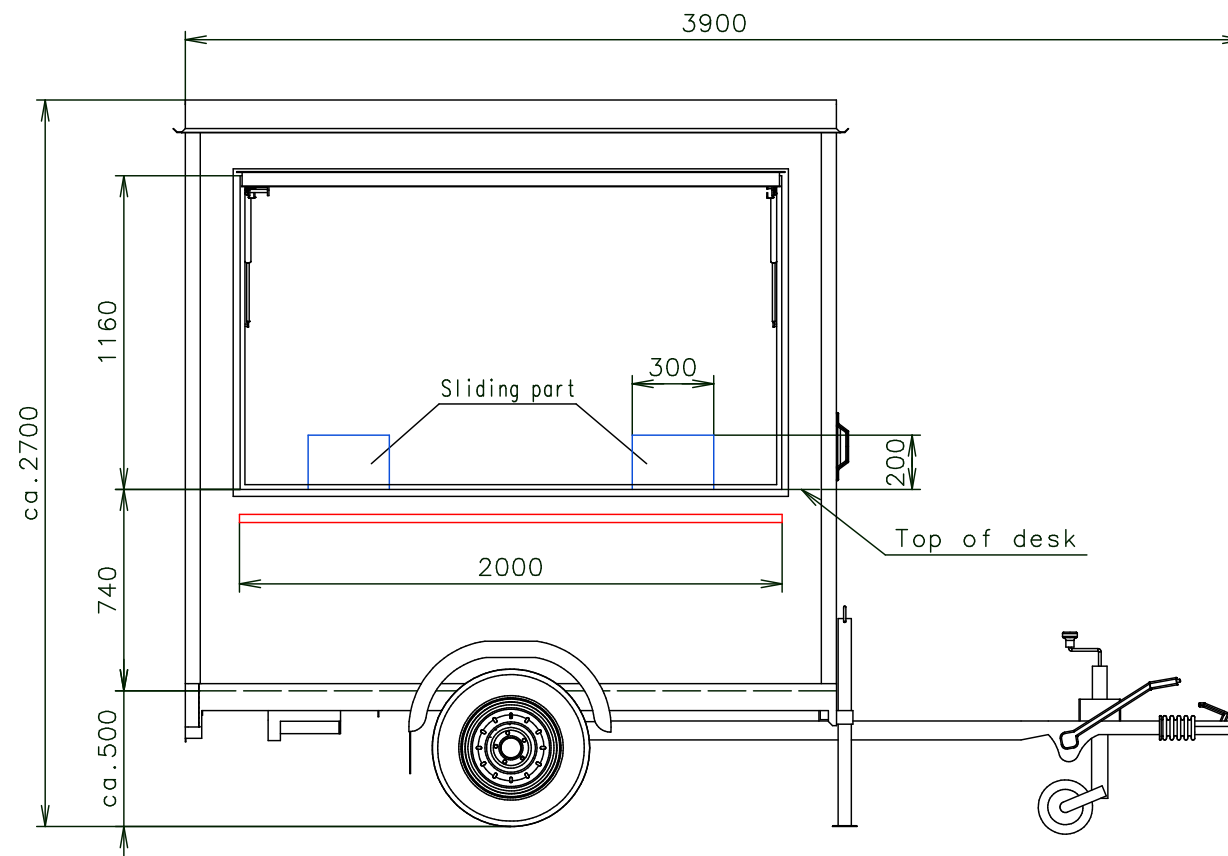



**EUROWAGON**

Drawing number:  
3362-24-2\_1/2 (Eventnight)

Connection hoses and cables	
Water hose:	✗
Waste water hose:	✗
Electric cable:	✓



-  Electric connection (on the chassis) (230V-16A)
-  Power point
-  Double power point
-  Light switch
-  Switch board (under roof)
-  LED spotlight
-  Heating (500W)

-  LED droplight
-  Ventilation ø120
-  Chair
-  Stairs Type 17

(Cabling and piping is not shown on the 3D views and drawings)

Notes:

Interior height:	2100 mm	Total weight:	750 kg
Color:	RAL 9010	Tare weight-estimate:	600 kg
Floor:	PVC gray	Centre of wheels from rear side:	1200 mm
Date:	6.9.2019	Wheels:	165/70 R13

**EUROWAGON**

Drawing number:  
3362-24-2\_2/2 (Eventnight)