

Connection hoses and cables	
Water hose:	✗
Waste water hose:	✗
Electric cable:	✓ Schuco

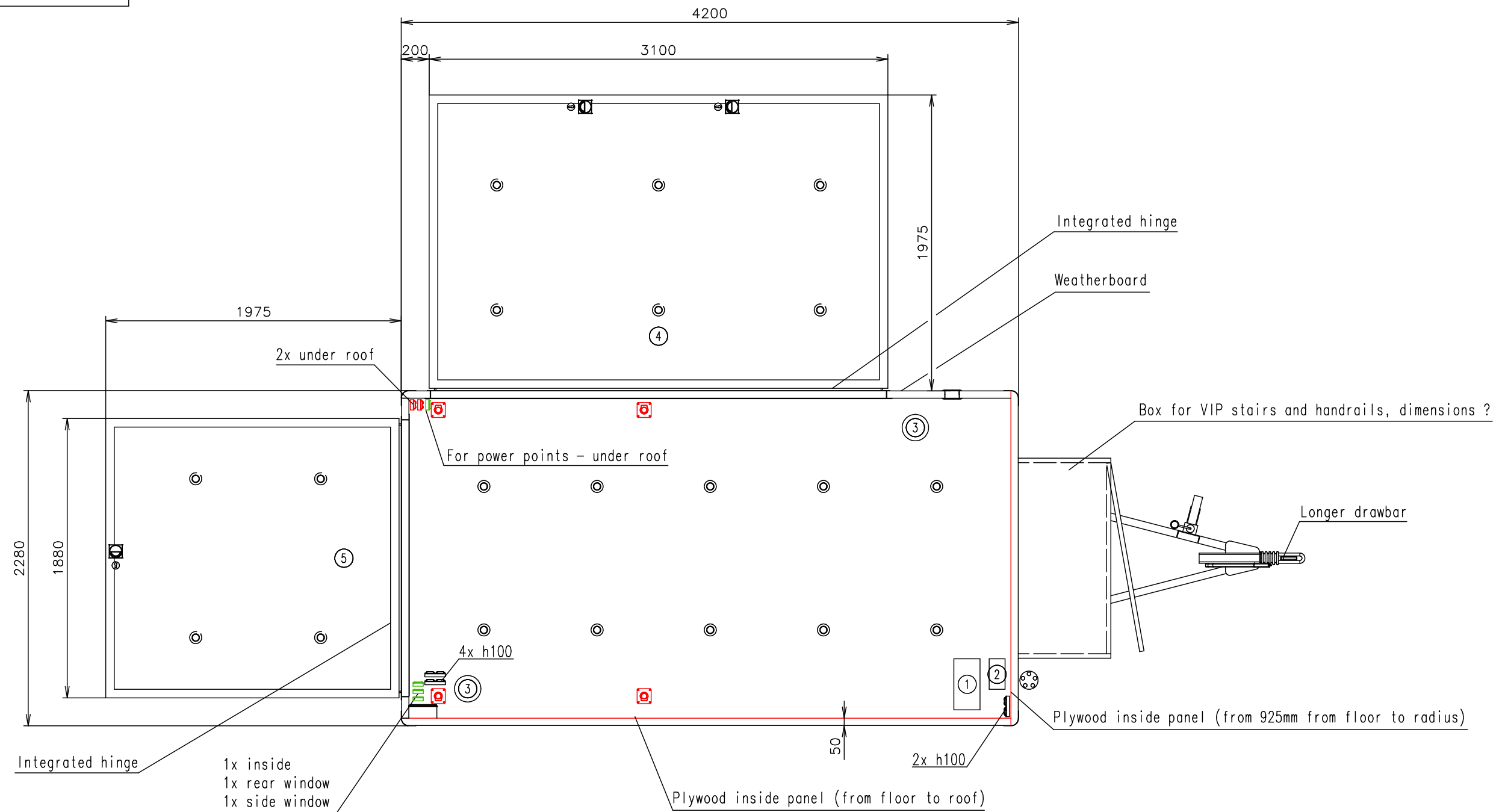

Too high coupling weight - will be balanced by customer - under 100kg

Notes: Battery only for spot lights Heating 750W free loaded







Interior height:	2200 mm	Total weight:	1400 kg
Color:	RAL 9010	Tare weight-estimate:	1200 kg
Floor:	PVC Jupiter 142704	Centre of wheels from rear side:	2120 mm
Date:	18.3.2016	Wheels:	195/50 R13C

EUROWAGON

Drawing number:
1800-42-4_1/2 (WestBay)

(Cabling and piping is not shown on the 3D views and drawings)

Connection hoses and cables	
Water hose:	✗
Waste water hose:	✗
Electric cable:	✓ Schuco

-  Electric connection (on the wall ca.1000 over ground level) (230V-16A)
-  Double power point
-  Double power point with switch
-  Light switch
-  Switch board (under roof)
-  Spot light

 Ventilation ø120

 Fixing eye in floor (UP-01)

① Battery Banner Energy Bull 110Ah (12V)

② Charger Multi XS 10A

③ Speaker - white - recessed into roof
- cable go to the switchboard

④ VIP stairs (2 parts) + 2x handrail

⑤ VIP stairs + 2x handrail

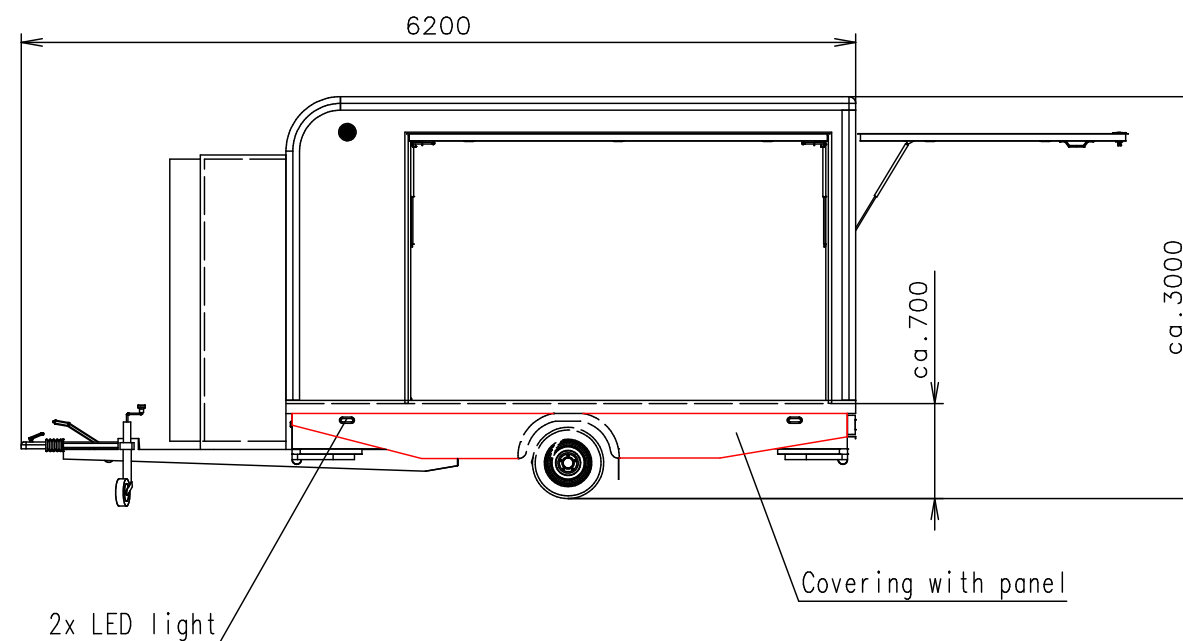

(Cabling and piping is not shown on the 3D views and drawings)

Too high coupling weight - will be balanced by customer - under 100kg

Notes: Battery only for spot lights Heating 750W free loaded

Interior height:	2200 mm	Total weight:	1400 kg
Color:	RAL 9010	Tare weight-estimate:	1200 kg
Floor:	PVC Jupiter 142704	Centre of wheels from rear side:	2120 mm
Date:	18.3.2016	Wheels:	195/50 R13C

EUROWAGON

Drawing number:
1800-42-4_2/2 (WestBay)