

Connection hoses and cables		
Water hose:	✓	Geka
Waste water hose:	✓	3x20m
Electric cable:	✓	

Geka connections

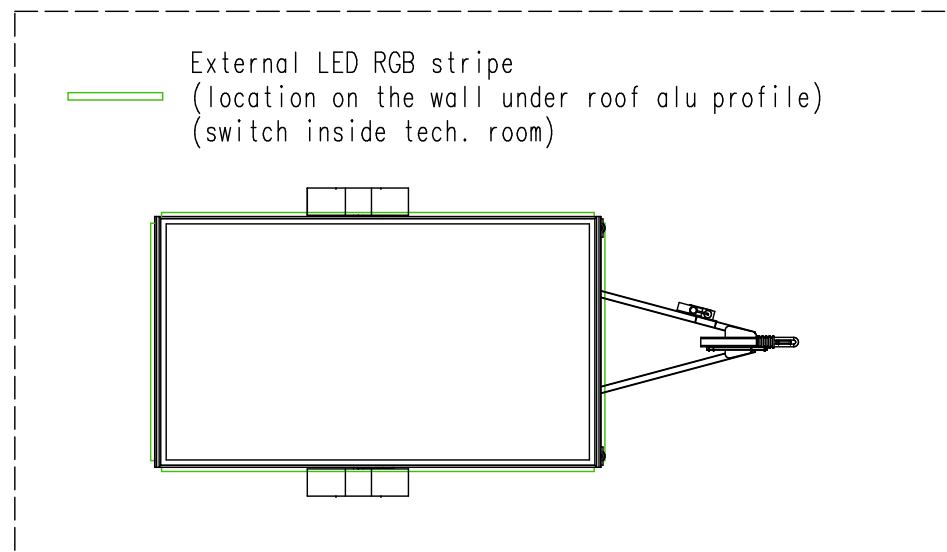
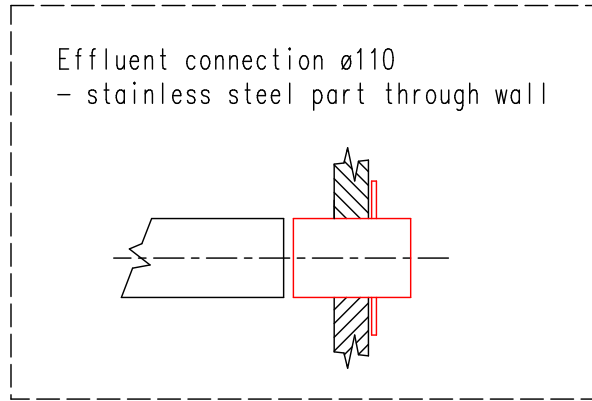
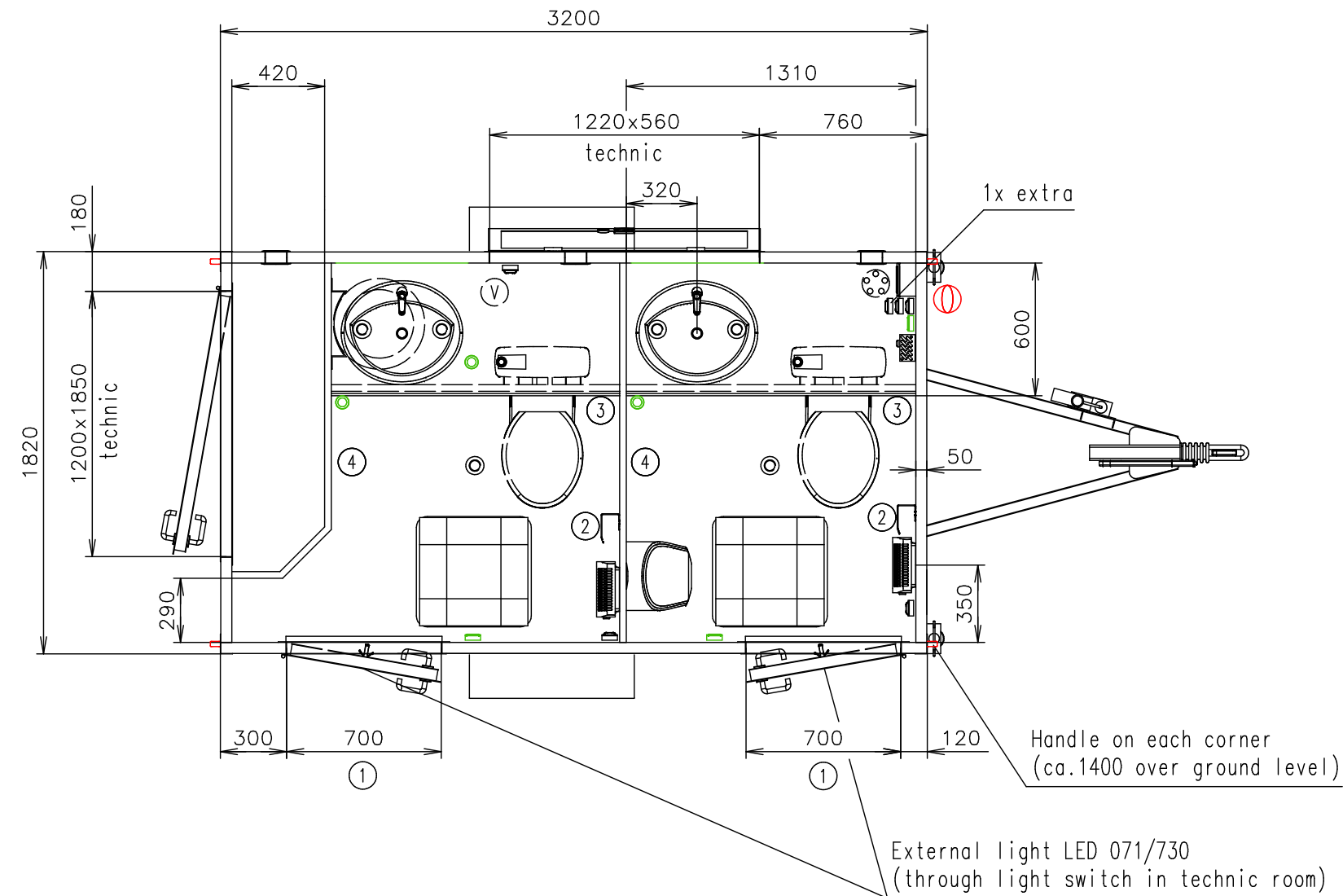

Pump BLUEBOX 150 + pump Zenit DG Blue PRO (free loaded)

Notes: Working desks in waterproof compact desk Egger (dark color)

Interior height:	2200 mm	Total weight:	1800 kg
Color:	RAL 9010	Tare weight-estimate:	1000 kg
Floor:	PVC black	Centre of wheels from rear side:	1500 mm
Date:	4.10.2021	Wheels:	195/50 R13C























**EUROWAGON**

Drawing number:  
3921-32-1\_1/2 (Krumkühler)

(Cabling and piping is not shown on the 3D views and drawings)

Connection hoses and cables		
Water hose:	✓	Geka
Waste water hose:	✓	3x20m
Electric cable:	✓	

Geka connections

-  Water connection 3/4" (through the floor) + filter + reduction valve (connection point Geka 3/4")
-  Electric connection (through the floor) (400V-16A)
-  Effluent connection ø110 (through wall) - stainless steel part
-  Power point
-  Light switch
-  Switch board (500 over floor)
-  LED spotlight
-  External LED RGB stripe
-  Heating (500W)
-  Heating (200W)
-  Floor drain hole
-  Wash-basin (built-in) Multi 1690 (550x470) + sensor water tap Sanela (mixed water)
-  Urinal - Vitra Siko (sensor water flush)
-  Hanging toilet
-  Hot water boiler (30 l) + mixing water
-  Roof window Dometic (400x400)
-  Ventilation ø120
-  Toilet paper holder
-  Clothes hanger
-  Mirror (600x600)
-  ① Foldable stairs Serena
-  ② Stainless steel tube (vertically) for extra 3 toilet papers (over toilet paper holder)
-  ③ Brush toilet Sanela SLZN 19X
-  ④ Handdryer Dyson Airblade AB14 gray (customer supply)

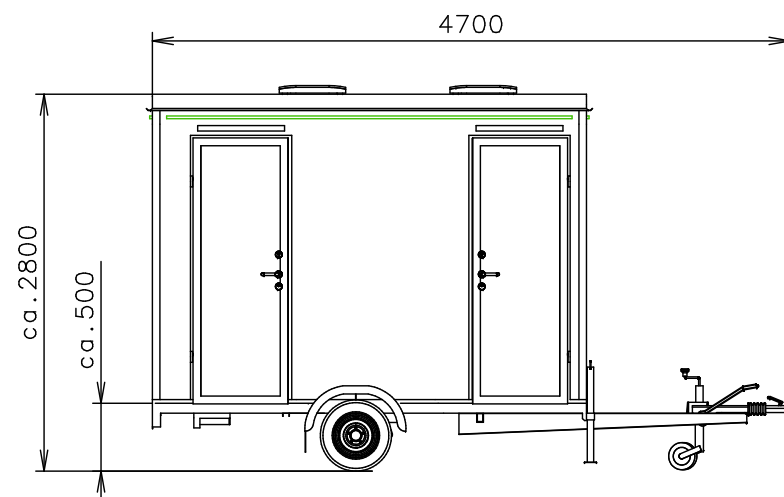

(Cabling and piping is not shown on the 3D views and drawings)

Pump BLUEBOX 150 + pump Zenit DG Blue PRO (free loaded)

Notes: Working desks in waterproof compact desk Egger (dark color)

Interior height:	2200 mm	Total weight:	1800 kg
Color:	RAL 9010	Tare weight-estimate:	1000 kg
Floor:	PVC black	Centre of wheels from rear side:	1500 mm
Date:	4.10.2021	Wheels:	195/50 R13C

**EUROWAGON**

Drawing number:  
3921-32-1\_2/2 (Krumkühler)