

Connection hoses and cables	
Water hose:	✗
Waste water hose:	✗
Electric cable:	✓

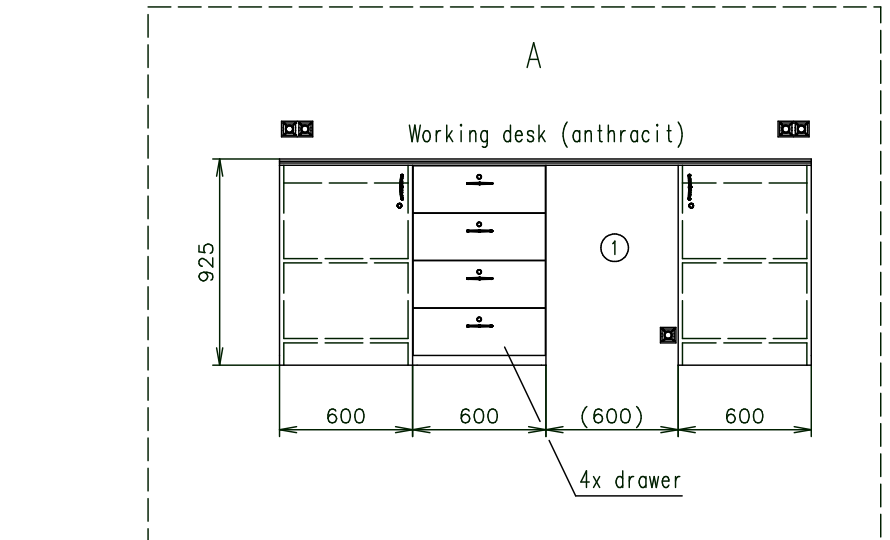

External light LED 071/730 (through light switch beside door)

Notes: External LED lights

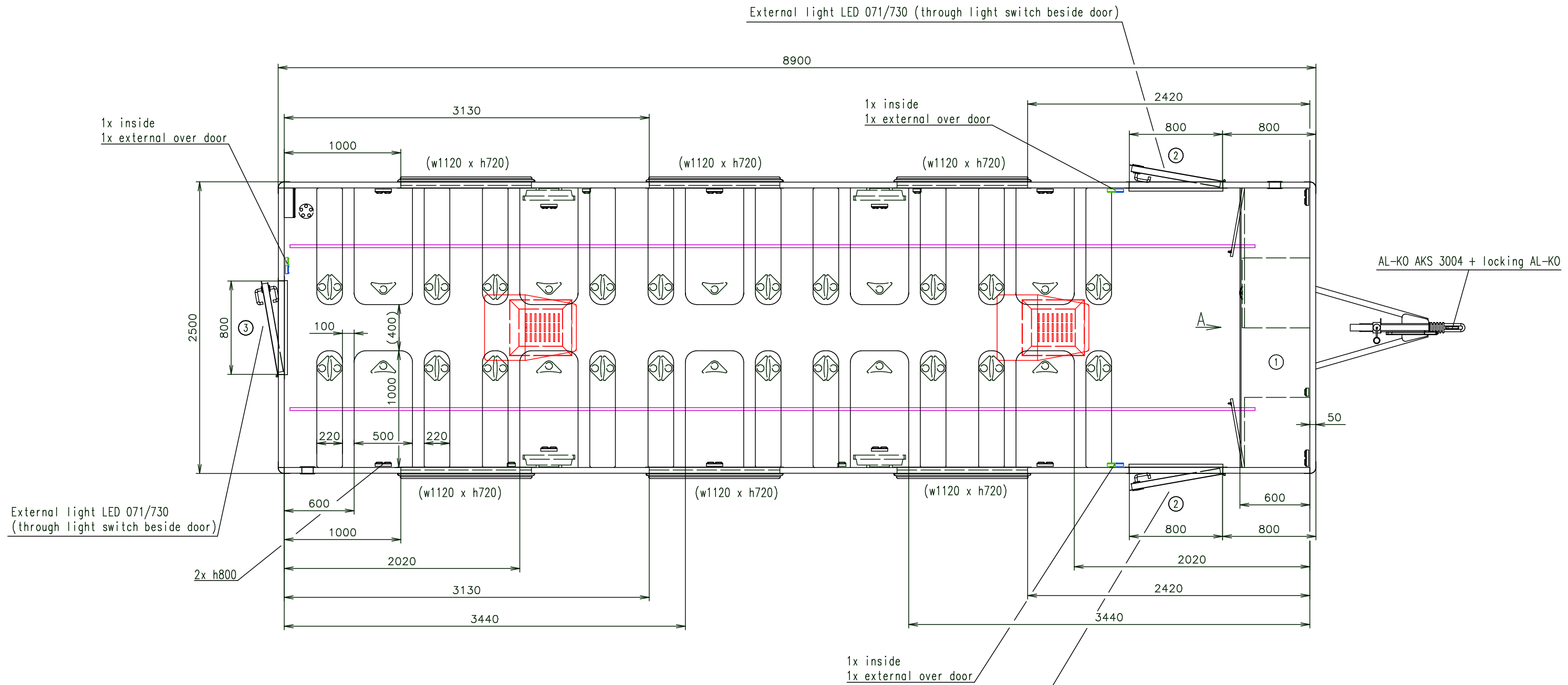











Interior height:	2300 mm	Total weight:	3000 kg
Color:	RAL 9010	Tare weight-estimate:	2600 kg
Floor:	PVC Jupiter 142702	Centre of wheels from rear side:	4490 mm
Date:	7.12.2016	Wheels:	195/50 R13C

EUROWAGON

Drawing number:
2470-89-2_1/2

(Cabling and piping is not shown on the 3D views and drawings)

Connection hoses and cables	
Water hose:	✗
Waste water hose:	✗
Electric cable:	✓

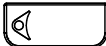
-  Electric connection (on the chassis) (400V-32A)
-  Power point
-  Double power point
-  Light switch
-  Light switch
-  Switch board (under roof)
-  LED stripe (warm white)
-  Heating (750W)
-  Roof A/C + heating (Dometic Freshjet 1700)
+ outside covering - 2x steel flat bar
-  Fixed window (970 over floor)
+ roller (blue dark) (inside)
-  Ventilation ø120
-  Desk permanent fixed
(1000x500)
-  Bench (black upholstered)
- ① Place for fridge
- ② Foldable stairs Oliver (w700)
- ③ VIP stairs (w700)

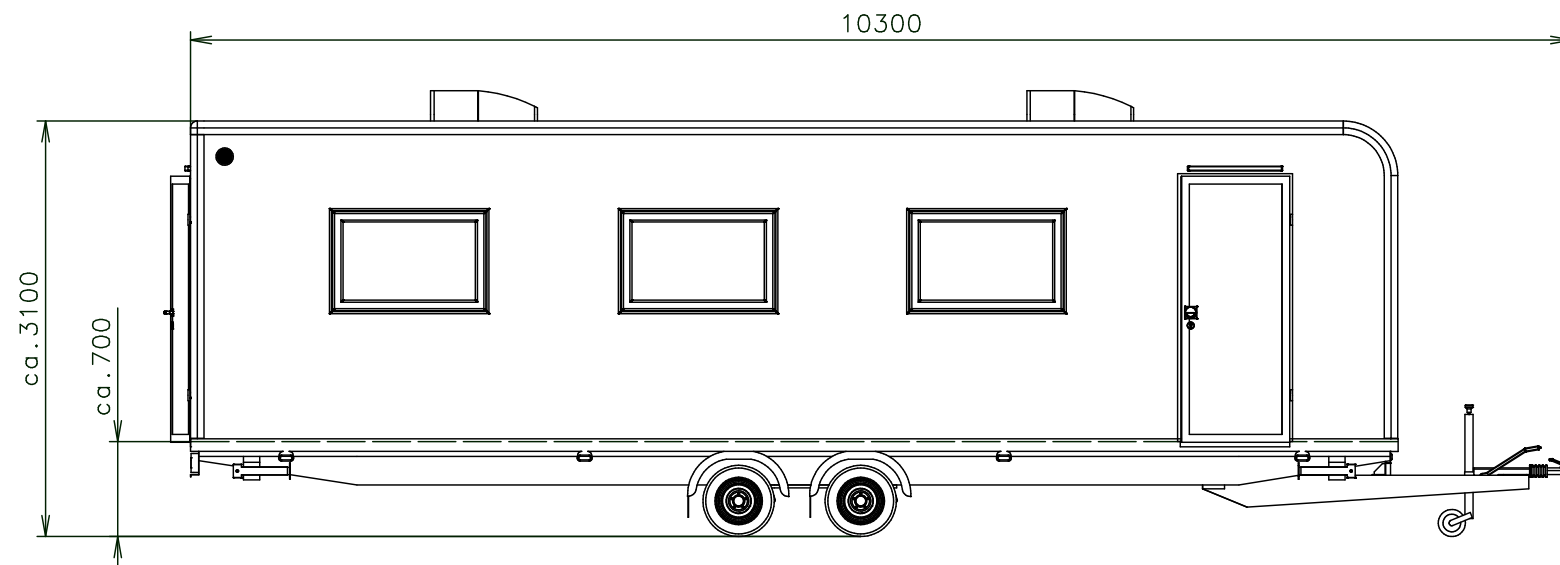

(Cabling and piping is not shown on the 3D views and drawings)

Notes: External LED lights

Interior height:	2300 mm	Total weight:	3000 kg
Color:	RAL 9010	Tare weight-estimate:	2600 kg
Floor:	PVC Jupiter 142702	Centre of wheels from rear side:	4490 mm
Date:	7.12.2016	Wheels:	195/50 R13C

EUROWAGON

Drawing number:
2470-89-2_2/2